

Operation Manual



Preface

The manual is intended to provide detailed information of product information, installation, application, trouble shooting, precautions and maintenance of iMars series grid-tied solar inverters. The manual does not contain all the information of the photovoltaic system. Please read this manual carefully and follow all safety precautions seriously before any moving, installation, operation and maintenance to ensure correct use and high performance of operation on the inverter.

The use of iMars series grid-tied solar inverters must comply with local laws and regulations on grid-tied power generation.

The manual needs to be kept well and be available at all times.

All rights reserved. The contents in this document are subject to change without notice.

There may be data deviation because of product improving. Detailed information is in accordant with the final product.

Contents

Preface	1
Contents	2
1 Safety precautions	4
1.1 Icons	5
1.2 Safety guidelines	5
1.2.1 Delivery and installation	6
1.2.2 Grid-tied operation	7
1.2.3 Maintenance and inspection	7
1.2.4 What to do after scrapping	8
2 Product overview	9
2.1 Solar grid-tied power generation system.....	10
2.2 Products appearance	12
2.3 Nameplate.....	13
2.4 DRM instruction.....	14
2.5 Products modules.....	15
2.6 Dimensions and weight	16
3 Storage	18
4 Installation	19
4.1 Unpacking inspection	20
4.2 Before installation.....	21
4.2.1 Installation tools.....	21
4.2.2 Installation place.....	21
4.2.3 Connection cables	23
4.2.4 Miniature circuit breakers.....	23
4.3 Mechanical installation	24
4.3.1 Installation of single-phase inverter.....	24
4.4.1 Connection of solar modules	27

4.4.2 AC connection	29
5 Operation.....	30
5.1 Inspection before operation	31
5.2 Grid-tied operation.....	31
5.3 Stopping.....	32
5.4 Daily maintenance.....	32
5.4.1 Regular maintenance.....	32
5.4.2 Maintenance guide	33
6 Display panel.....	34
6.1 LED indicators.....	35
6.2 Operation panel.....	36
6.3 LCD screen	37
6.4 Functions operation.....	38
6.4.1 Monitoring parameters.....	38
6.4.2 History	38
6.4.3 Statistics.....	38
6.4.4 Parameter settings	39
6.4.5 System Information.....	46
6.4.6 Faults	46
6.4.7 Inverter control.....	46
6.4.8 Mode settings.....	47
6.5 Grid Certification Choice.....	48
7 Monitoring communication	51
7.1 RS485-M and CT/METER ports	52
7.1.1 Standard communication	52
7.2 RS485-DRM ports	54
8 Troubleshooting.....	55
9 Technical parameters	58

1 Safety precautions

iMars series grid-tied solar inverters are designed and tested strictly in accordance with relevant international safety standards. As an electrical and electronic device, all relevant safety regulations must be strictly complied during installation, operation, and maintenance. Incorrect use or misuse may result in:

- Injury to the life and personal safety of the operator or other people.
- Damage to the inverter or other property belonging to the operator or other people.









In order to avoid personal injury, damage to the inverter or other devices, please strictly observe the following safety precautions.

This chapter mainly describes various warning symbols in operation manual and provides safety instructions for the installation, operation, maintenance and use of the iMars series grid-tied solar inverters.



1.1 Icons





This manual provides relevant information with icons to highlight the physical and property safety of the user to avoid device damage and physical injury.

The icons used in this manual are listed below:

Icons	Name	Instruction	Abbreviation
 Danger	Danger	Serious physical injury or even death may occur if not follow the relative requirements	
 Warning	Warning	Physical injury or damage to the devices may occur if not follow the relative requirements	
 Do not	Do not	Damage may occur if not follow the relative requirements	
 Hot sides	Hot sides	Sides of the device may become hot. Do not touch.	
Note	Note	Physical hurt may occur if not follow the relative requirements	Note

1.2 Safety guidelines

	<ul style="list-style-type: none"> ● The first thing after receiving is to check for any visible damage to the package or to the inverter. If there is something suspected, contact the shipping company and local dealer before installing. ● Only qualified electricians are allowed to operate on the inverter. ● Do not carry out any wiring and inspection or changing components when the power supply is applied.
	<ul style="list-style-type: none"> ● This product can cause a residual current in the external protective earth conductor. Where a residual current-operated protective (RCD) or monitoring (RCM) device is strongly recommend to used for protection in a case of direct or indirect contact, only an RCD or RCM of Type B is allowed on the supply side of this product;
	<ul style="list-style-type: none"> ● Ensure that there is no electromagnetic interference from other electrical and electronic equipments on the installation site. ● Do not refit the inverter unauthorized.

	<ul style="list-style-type: none"> ● All the electric installation needs to be compliance with the national or local laws and standards.
	<ul style="list-style-type: none"> ● The temperature of individual parts or the enclosure of the inverter—especially the heat sink may become hot in normal operation. There is a danger of burning. Do not touch.
	<ul style="list-style-type: none"> ● Do not open the cover of inverters unauthorizedly. The electrical parts and components inside the inverter are electrostatic. Take measurements to avoid electrostatic discharge during relevant operation.
	<ul style="list-style-type: none"> ● The inverter must be reliably grounded.
	<ul style="list-style-type: none"> ● Ensure that DC and AC side circuit breakers have been disconnected and wait at least 5 minutes before wiring and checking.
<p>Note: Technical personnel who can perform installation, wiring, commissioning, maintenance, troubleshooting and replacement of the iMars series grid-tied solar inverters must meet the following requirements:</p>	
<ul style="list-style-type: none"> ● Operators need professional training. ● Operators must read this manual completely and master the related safety precautions. ● Operators need to be familiar with the relevant safety regulations for electrical systems. ● Operators need to be fully familiar with the composition and operating principle of the entire grid-tied photovoltaic power generation system and related standards of the countries/regions in which the project is located. ● Operators must wear personal protective equipment. 	

1.2.1 Delivery and installation

	<ul style="list-style-type: none"> ● Keep the package and unit complete, dry and clean during storage and delivery. ● Please remove and install the inverter with two or more people, because of the inverter is heavy. ● Remove and install the inverter with appropriate tools to ensure safe and normal operation and avoid physical injury or death. The people also need mechanical protective measures, such as protective shoes and work clothes. ● Only qualified electricians are allowed to install the inverter.
---	---

	<ul style="list-style-type: none"> ● Do not put and install the inverter on or close to combustible materials. ● Keep the installation site away from children and other public places. ● Remove the metal jewelry such as ring and bracelet before installation and electrical connection to avoid electric shock. ● Do cover solar modules with light-tight materials. Exposed to sunlight, solar modules will output dangerous voltage. ● The inverter input voltage does not exceed the maximum input voltage; otherwise inverter damage may occur. ● The positive and negative pole of solar modules can not be grounded, otherwise irrecoverable damage may occur. ● Ensure the proper grounding of the inverter, otherwise, improper connection or no grounding may cause stop of the inverter. ● Ensure reliable installation and electrical connection. ● When the photovoltaic generator cells are exposed to light (even if it is dim), the generator supplies DC voltage to the inverter.
--	--

Note: iMars series grid-tied solar inverters are only for crystalline silicon solar modules.

1.2.2 Grid-tied operation

	<ul style="list-style-type: none"> ● Only qualified electricians are allowed to operate the inverter under the permission of local power departments. ● All electrical connections must meet the electrical standards. of the countries/regions in which the project is located. ● Ensure reliable installation and electrical connection before operation. ● Do not open the cover of inverter during operation or voltage is present.
---	---

1.2.3 Maintenance and inspection

	<ul style="list-style-type: none"> ● Only qualified electricians are allowed to perform the maintenance, inspection, and components replacement of the inverter. ● Contact with the local dealer or supplier for maintenance. ● In order to avoid irrelevant personnel from entering the maintenance area during maintenance, temporary warning labels must be placed to warn non-professionals to enter or use fence for isolation. ● Firstly disconnect all power supplies of the grid to the inverter before any maintenance, and then disconnect the breakers and wait for at least 5 minutes
---	---

	<p>until the inverter is discharged before maintenance.</p> <ul style="list-style-type: none">● Please follow electrostatic protection norms and take correct protective measures because of the electrostatic sensitive circuits and devices in the inverter.● Do not use parts and components not provided by our company during maintenance.● Restart the inverter after settling the fault and problem which may affect the safety and performance of the inverter.● Do not get close to or touch any metal conductive part of the grid or inverter, otherwise electric shock, physical injury or death and fire may occur. Please do not ignore the warning icons and instructions with “electric shock”.
--	---

1.2.4 What to do after scrapping

	<ul style="list-style-type: none">● Do not dispose of the inverter together with household waste. The user has the responsibility and obligation to send it to the designated organization for recycling and disposal.
---	--

2 Product overview

This chapter mainly describes the appearance, packaging accessories, name plate, technical parameters and other information of iMars series grid-tied solar inverters.

2.1 Solar grid-tied power generation system

2.1.1 Application

The photovoltaic grid-tied power generation system consists of solar modules, grid-tied inverter, metering devices and public grid.

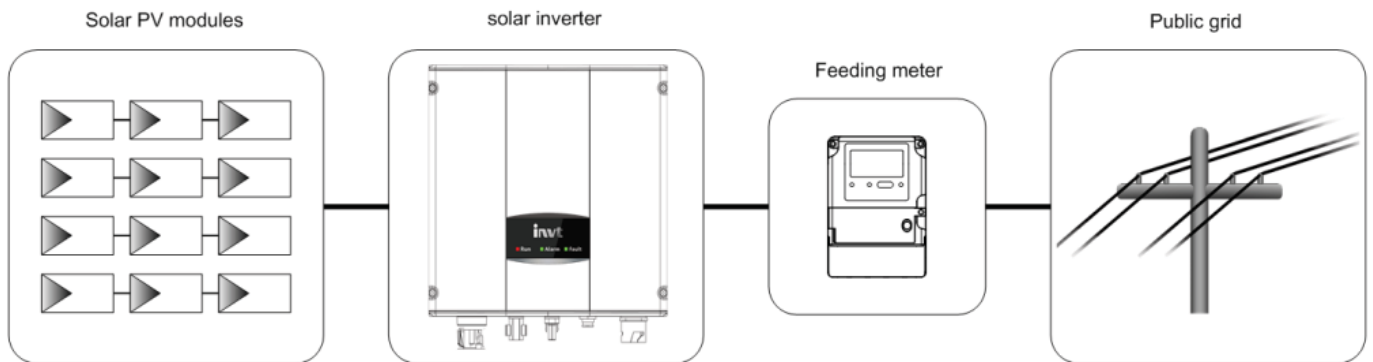

Figure 2.1 Application of iMars series grid-tied solar inverters

Grid-tied solar inverter is the core of photovoltaic power generation system. The solar energy can be converted into DC electric energy through solar modules and then be changed into sinusoidal AC energy which has the same frequency and phase with the public grid by grid-tied solar inverters, and then be fed to the grid.

iMars series grid-tied solar inverters are only applied in solar grid-tied power generation system and its DC input are only composed of crystalline silicon solar modules whose negative and positive poles are not grounded.



- The recommended solar modules need to comply with IEC61730 Class A rating.
- iMars series grid-tied solar inverters are only for crystalline silicon solar modules.

2.1.2 Supported grid connection structure

iMars series grid-tied solar inverters support TN-S, TN-C, TN-C-S and TT grid connection. When applied to the TT connection, the N-to-PE voltage should be less than 30V.

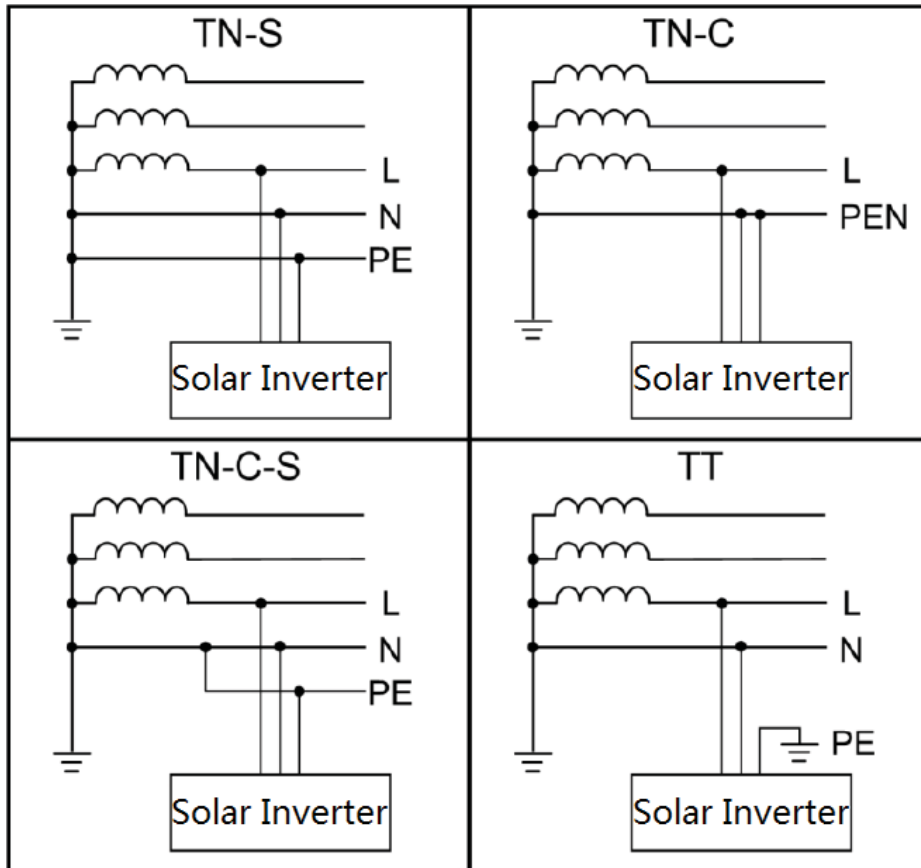

Figure 2.2 Type of grid

2.2 Products appearance

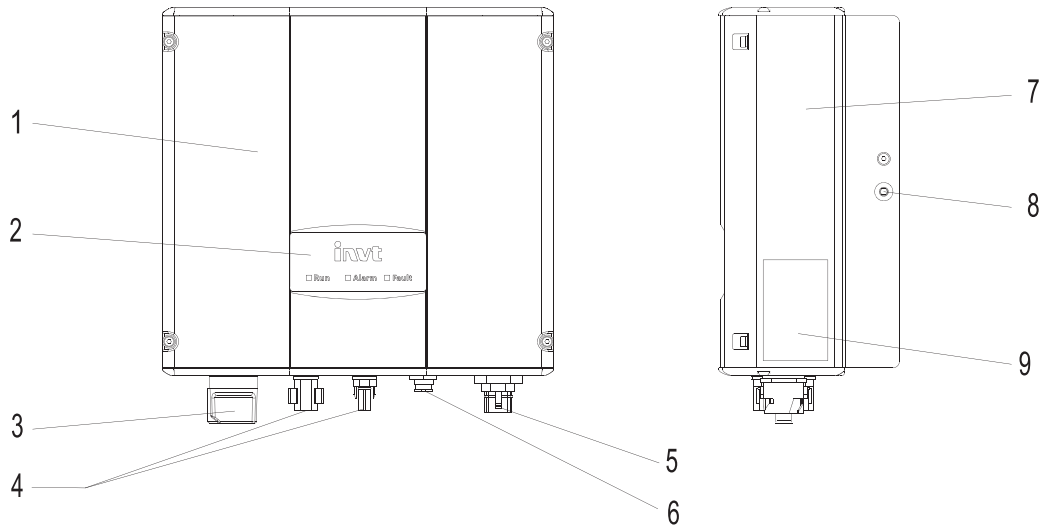

Figure 2.3 Products appearance

Table 2-1 Parts instruction

No.	Name	Instruction
1	Cover	
2	Operational panel	LED indicators
3	DC switch	On –off of the DC input (optional)
4	DC input port	For the connection of solar modules
5	AC terminal	For the connection of AC output
6	Communication port	RS485 and EXT communication port
7	Cooling chamber	
8	Radiator	
9	Name plate	For rated parameters and safety precautions of the inverter

2.3 Nameplate





invt		Grid-tied Solar Inverter	1
iMars MG5K5TL-2M			
DC Input			
Vmax. PV	600V		
MPPT Range	125V-550V		
Max. Current	12AX2		
Isc PV	14AX2		
AC Output			2
Nominal Voltage	230V		
Nominal Current	22.7A		
Rated Power	4999W		
Frequency	50Hz/60Hz		
Power factor range	0.95un ~0.95ov		
Environment			
Temperature	-25°C ~ +60°C		
Protective Class	I		
Inverter topology	Non-isolated		
Ingress protection	IP65		
			3
<div style="border: 1px dashed black; height: 40px; width: 100%;"></div>			4
Made in China			
INVT Solar Technology (Shenzhen) Co.,Ltd.			

Figure 2.4 Inverter nameplate

- (1) Trademark and product type
- (2) Model and important technical parameters
- (3) Certification system of the inverter confirming
- (4) Serial number, company name and country of origin.

Icons	Instruction
	<ul style="list-style-type: none"> TUV certification mark. The inverter is certified by TUV.
	<ul style="list-style-type: none"> CE certification mark. The inverter complies with the CE directive.
	<ul style="list-style-type: none"> CQC certification mark. The inverter is certified by CQC.
	<ul style="list-style-type: none"> EU WEEE mark. Cannot dispose of the inverter as household waste.

2.4 DRM instruction

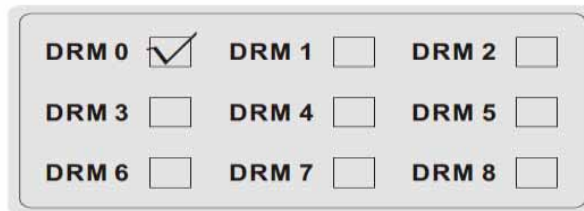

Figure 2.5 DRM label

Table 2-2 DRMs instruction

No.	Mode	Requirement
1	DRM0	Operter the disconnection devise
2	DRM1	Do not consume power
3	DRM2	Do not consume at more than 50% of rated power
4	DRM3	Do not consume at more than 75% of rated power AND Source reactive power if capable
5	DRM4	Increase power consumption(subject to constraints from other active DRMs)
6	DRM5	Do not generate power
7	DRM6	Do not generate at more than 50% of rated power
8	DRM7	Do not generate at more than 75% of rated power AND Sink reactive power if capable
9	DRM8	Increase power generation(subject to constraints from other active DRMs)

Note: Our product only realize the DRM0 function

2.5 Products modules

Table 2-3 Models of iMars grid-tied solar inverter

Product name	Model	Rated output power
Single-phase (L, N, PE)		
Single-phase grid-tied solar inverter	iMars MG750TL	750
Single-phase grid-tied solar inverter	iMars MG1KTL	1000
Single-phase grid-tied solar inverter	iMars MG1K5TL	1500
Single-phase grid-tied solar inverter	iMars MG2KTL	2000
Single-phase grid-tied solar inverter	iMars MG3KTL	3000
Single-phase grid-tied solar inverter	iMars MG4KTL	3680
Single-phase grid-tied solar inverter	iMars MG4K6TL	4200
Single-phase grid-tied solar inverter	iMars MG5KTL	4600
Single-phase grid-tied solar inverter	iMars MG3KTL-2M	3000
Single-phase grid-tied solar inverter	iMars MG4KTL-2M	3680
Single-phase grid-tied solar inverter	iMars MG4K6TL-2M	4200
Single-phase grid-tied solar inverter	iMars MG5KTL-2M	4600
Single-phase grid-tied solar inverter	iMars MG5K5TL-2M	4999

Note: Refer to the product specifications in chapter 9 for detailed information.

2.6 Dimensions and weight

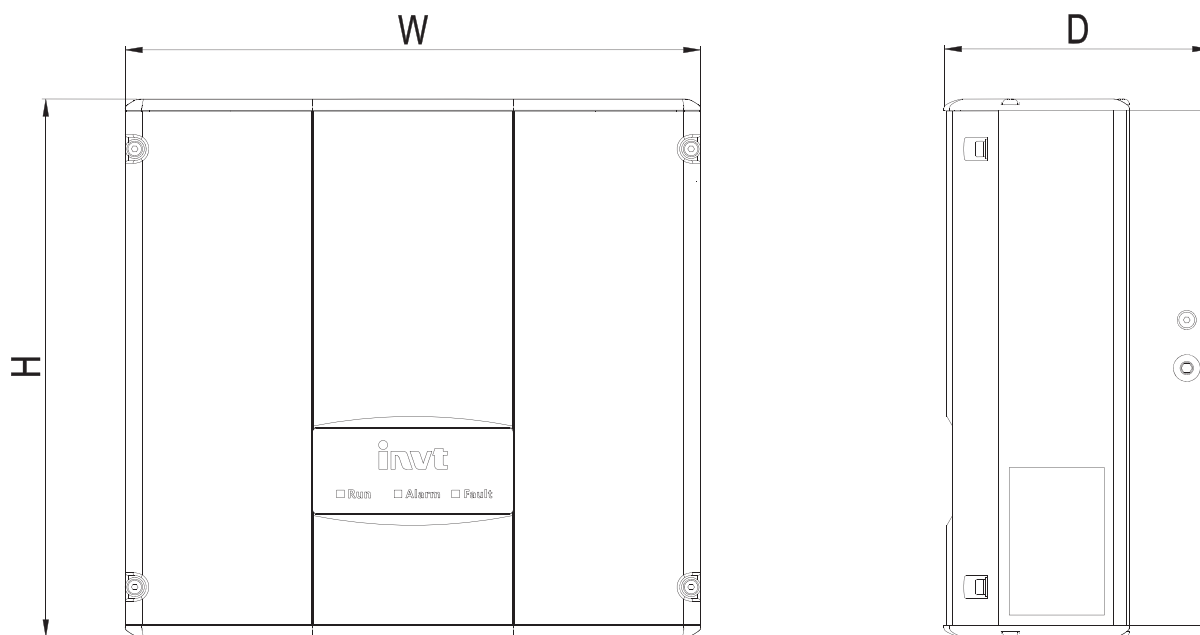

Figure 2.6 Inverter dimensions

Table 2-4 Inverter dimension and net weight

Model	H (mm)	W (mm)	D (mm)	Net weight (kg)
MG750TL / MG1KTL / MG1K5TL / MG2KTL / MG3KTL	280	300	138	9.5
MG4KTL / MG4K6TL / MG5KTL	365	360	150	15
MG3KTL-2M / MG4KTL-2M / MG4K6TL-2M / MG5KTL-2M / MG5K5TL-2M	420	360	150	17

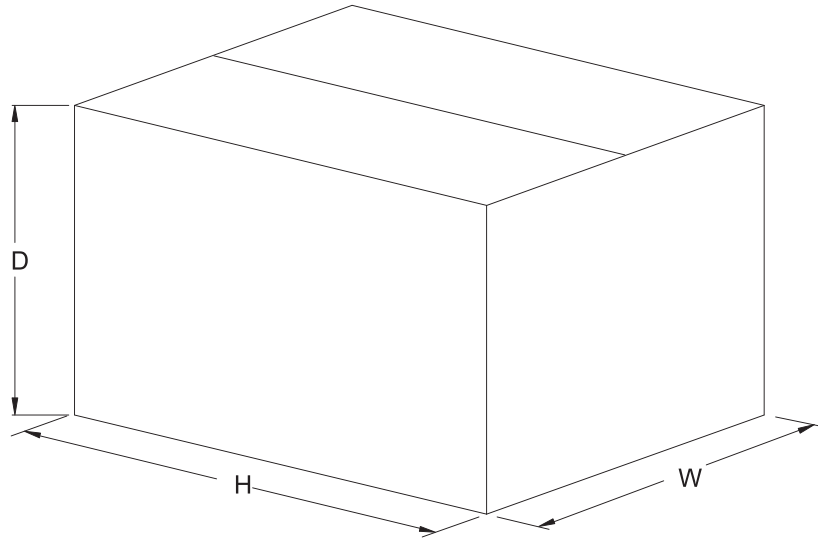

Figure 2.7 Paper packages dimension

Table 2-5 Packages dimension and gross weight

Model	H (mm)	W (mm)	D (mm)	Gross weight (kg)	Packagin g Material
MG750TL / MG1KTL / MG1K5TL / MG2KTL / MG3KTL	411	418	251	11	Paper
MG4KTL/MG4K6TL	518	480	284	17	Paper
MG3KTL-2M / MG4K6TL / MG4KTL-2M / MG4K6TL-2M / MG5KTL-2M/ MG5K5TL-2M	573	480	284	19	Paper

3 Storage

If the inverter is not put into use immediately, the storage of inverter should meet the following requirements:

- Do not remove the outer packing.
- The inverter needs to be stored in a clean and dry place, and prevent the erosion of dust and water vapor.
- The storage temperature should be kept at $-40^{\circ}\text{C}\sim+70^{\circ}\text{C}$, and the relative humidity should be kept at $5\%\text{RH}\sim95\%\text{RH}$.
- The stacking of inverters is recommended to be placed according to the number of stacking layers in the original shipment. Place the inverter carefully during stacking to avoid personal injury or equipment damage caused by the falling of equipment.
- Keep away from chemically corrosive substances that may corrode the inverter.
- Periodic inspections are required. If damages are found by worms and rats, or packaging are found to be damaged, the packaging materials must be replaced in time.

After long-term storage, inverters need to be inspected and tested by qualified personnel before put into use.

4 Installation

This chapter describes how to install the inverter and connect it to the grid-tied solar system (including the connection between solar modules, public grid and inverter).

Read this chapter carefully and ensure all installation requirements are met before installation. Only qualified electricians are allowed to install the inverter.

4.1 Unpacking inspection

Inspect the information of the order and the name plate to ensure the product are the ordered one and no damage to the package. If any problem, contact the supplier as soon as possible.

Put the inverter into the package if not used and protect it from humidity and dust.

Check as following after unpacking:

- (1) Ensure no damage to the inverter unit.
- (2) Ensure the operation manual, port and installation accessories in the package.
- (3) Ensure no damage or loss to the items in the package.
- (4) Ensure the information of the order are the same as that of the name plate.

Packing list:

Table 4-1 Detailed delivery list of single-phase inverter

No.	Name	Quantity	
1	MG750TL / MG1KTL / MG1K5TL / MG2KTL / MG3KTL/ MG4KTL / MG4K6TL / MG5KTL/MG3KTL-2M / MG4KTL-2M /MG4K6TL-2M / MG5KTL-2M/ MG5K5TL-2M inverter	1	
2	Installation bracket	1	
3	operation manual	1	
4	Hexagon assembling bolt M5*20	2	
5	Expansion bolts M6*60	MG750TL / MG1KTL/MG1K5TL / MG2KTL / MG3KTL	3pcs
		MG4KTL / MG4K6TL / MG5KTL/ MG3KTL-2M / MG4KTL-2M / MG4K6TL-2M / MG5KTL-2M/ MG5K5TL-2M	4pcs
6	DC connector	MG750TL / MG1KTL / MG1K5TL / MG2KTL/MG3KTL	1 pair
		MG4KTL/MG4K6TL/MG5KTL/M G3KTL-2M/MG4KTL-2M/ MG4K6TL-2M/MG5KTL-2M/ MG5K5TL-2M	2 pairs
7	AC connector	1	

4.2 Before installation

4.2.1 Installation tools

Table 4-2 Tools list

No.	Installation tools	Instruction
1	Marking pen	Mark the installation hole
2	Electrodrill	Drill in the bracket or wall
3	Hammer	Hammer on the expansion bolts
4	Monkey wrench	Fix the installation bracket
5	Allen driver	Fasten the screws, remove and install AC wiring box
6	Straight screwdriver	For AC wiring
7	Megger	Measuring insulation performance and impedance
8	Multimeter	Check the circuit and AC and DC voltage
9	Electric iron	Weld communications cable
10	Wire crimper	Crimp DC terminals

4.2.2 Installation place

Select installation place based on the following considerations:

- (1) Height from ground level should be enough to ensure that display and status LEDs are easy to read.
- (2) Select a well ventilated place sheltered from direct sun radiation and rain.
- (3) Allow sufficient space around the inverter to enable easy installation and removal from the mounting surface. Refer to Figure 4.1.
- (4) The environment temperature is between -25°C ~ 60°C .
- (5) The installation position keeps away from the interface of other electrical devise.
- (6) The inverter needs to be installed on a firm and sturdy surface, such as wall and metal bracket and so on.
- (7) The installation surface should be perpendicular to the horizontal line. Refer to Figure 4.2.
- (8) The installation should ensure that the inverter is reliably grounded, and the material of grounded metal conductor should be consistent with the metal material reserved for the grounding of the inverter.

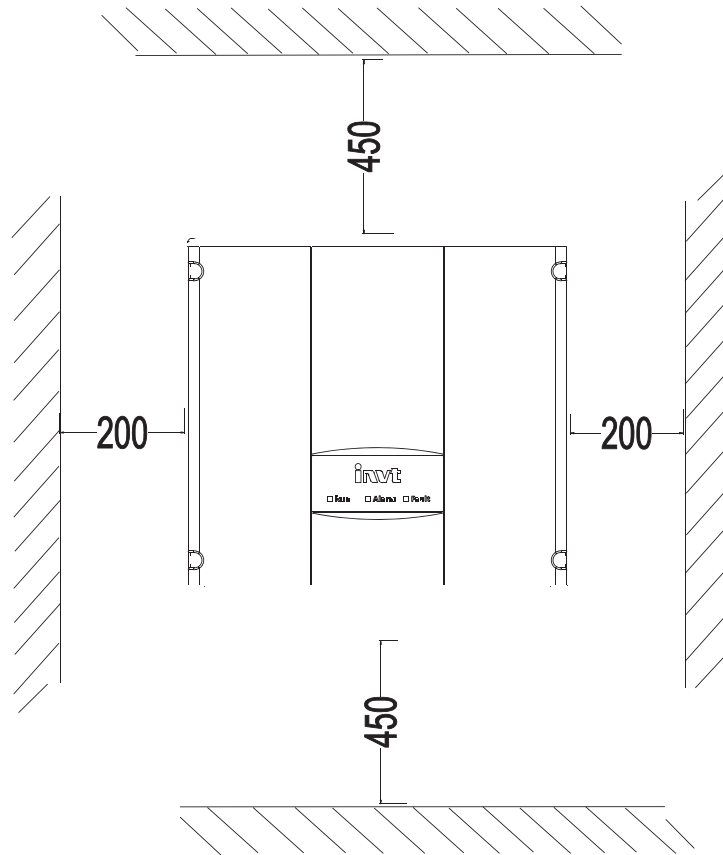

Figure 4.1 Installation space

Ensure there is sufficient space for heat-releasing. In generally, below space requirement should be met:

Table 4-3 Detailed installation space

	Minimum clearance
Lateral	200mm
Top	450mm
Bottom	450mm

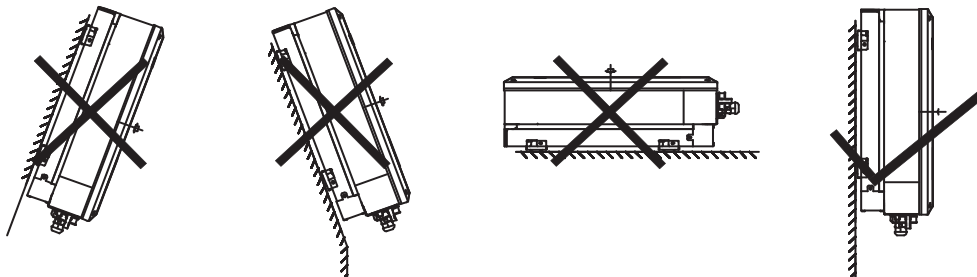

Figure 4.2 Installation position

	<ul style="list-style-type: none"> Do not remove any part and component of the inverter unintended; otherwise damage to the device and physical injury may occur.
--	--

4.2.3 Connection cables

The user can select connection cable according the table below:

Table 4-4 Cable specifications

Model	DC side		AC side	
	Cross-section (length ≤50m) mm ²	Cross-section (length >50m) mm ²	Mini cross-section mm ²	
			L	N/PE
MG750TL / MG1KTL / MG1K5TL / MG2KTL / MG3KTL	4	4	4	
MG4KTL / MG4K6TL / MG5KTL / MG3KTL-2M / MG4KTL-2M / MG4K6TL-2M / MG5KTL-2M/ MG5K5TL-2M	4	4	6	

4.2.4 Miniature circuit breakers

It is recommended strongly to install circuit breakers or fuses at the DC input and AC output to ensure safe installation and running.

	<ul style="list-style-type: none"> ● In order to protect the PCE, user and installer, external DC and AC circuit breaker shall be equipped at the end-use application. ● The wiring shall be according local electric code. Choose proper cable for power input and output lines. Input and output cable shall be PV private cables suitable for outdoor use.
---	---

Table 4-5 Breakers specifications

Model	DC input	AC output
	Recommended DC breakers (optional for length >100m)	Recommended AC breakers
MG750TL / MG1KTL/ MG1K5TL	DC500V, C10A, 2P	AC240V, C10A, 2P
MG2KTL	DC500V, C16A, 2P	AC240V, C16A, 2P
MG3KTL / MG3KTL-2M	DC500V, C16A, 2P	AC240V, C20A, 2P
MG4KTL / MG4KTL-2M	DC600V, C20A, 2P	AC240V, C25A, 2P
MG4K6TL / MG5KTL / MG4K6TL-2M / MG5KTL-2M/ MG5K5TL-2M	DC600V, C25A, 2P	AC240V, C32A, 2P

4.3 Mechanical installation

Since the installation place can be made by different construction materials, the inverter can be installed by different mounting methods. Take the typical installation environment as the example, the manual describes how to install the inverter on concrete wall. The inverter should be mounted in a vertical position of 90° to the horizontal line as shown in Figure 4.2.

4.3.1 Installation of single-phase inverter

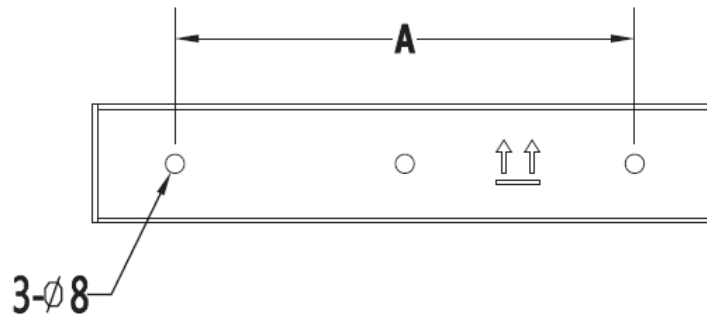

Figure 4.3 Installation bracket of 0.75~3kW inverter

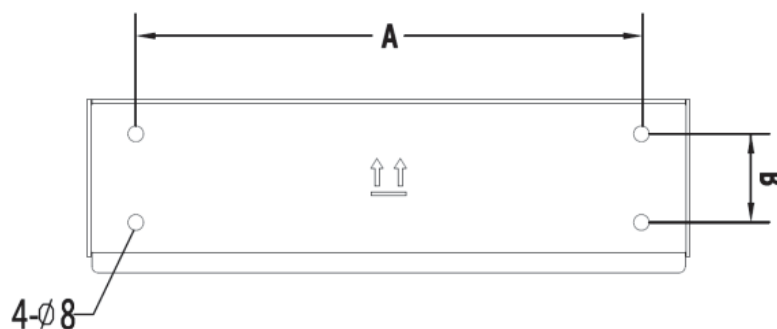

Figure 4.4 Installation bracket of 4~5kW inverter

Table 4-6 Size of installation bracket

Model	Installation hole
	A(mm)*B(mm)
MG750TL / MG1KTL / MG1K5TL / MG2KTL / MG3KTL	195
MG4KTL / MG4K6TL / MG5KTL / MG3KTL-2M / MG4KTL-2M / MG4K6TL-2M / MG5KTL-2M / MG5K5TL-2M	260*45

Table 4-7 Instruction of installation bracket

No.	Structure instruction
1	Installation hole $\Phi 8$
2	Hexagon assembling bolt hole M5

Installation steps:

- (1) At first, take down the installation bracket from the package.
- (2) Put the installation bracket at the appropriate height and position on the wall, mark the hole location according to the fixing hole, drill the hole to a depth of about 70mm and according to the arrow sign mounting the bracket.
- (3) Lift the inverter to suspend it on the installation bracket through M8 hex socket cap screws.
- (4) Finally, fasten M5 hex socket cap screws connecting the inverter with the bracket and tighten the screws to 2 Nm. For firm installation, the operators cannot release the device until the inverter is installed on the bracket firmly.

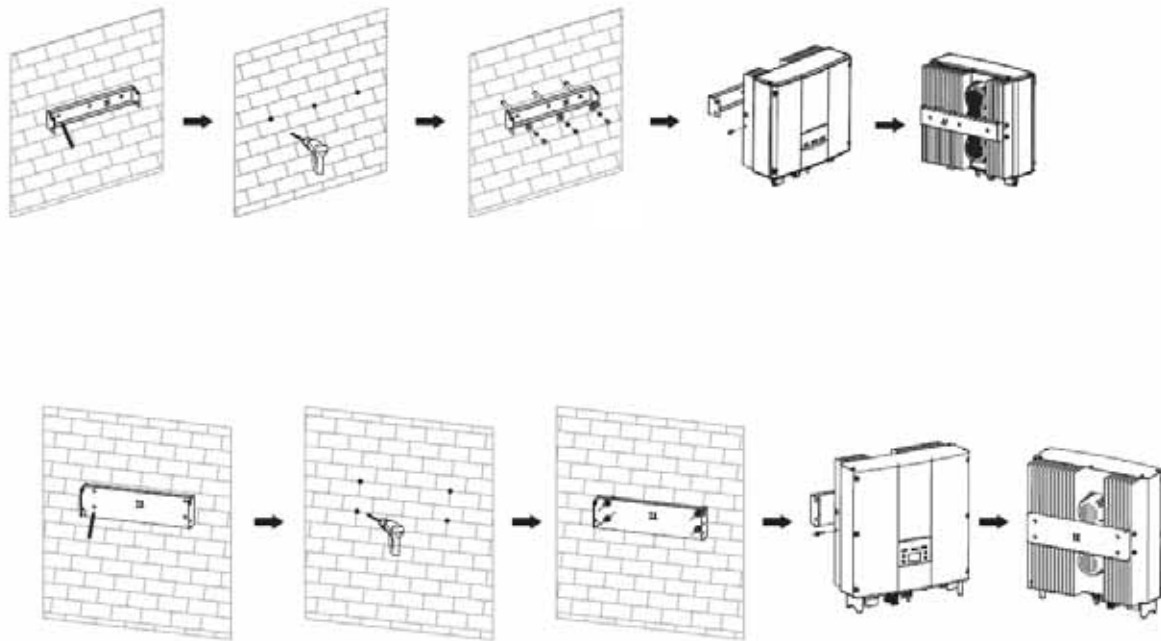

Figure 4.5 Installation of inverter

4.4 Electrical installation

This section proposes to describe detailed electrical installation and related safety instructions.

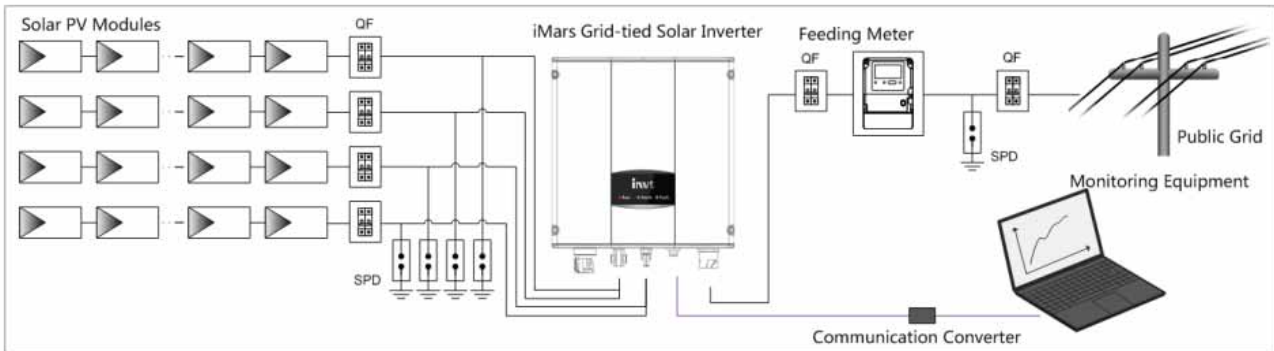



Figure 4.6 Block diagram of the grid-tied solar system

	<ul style="list-style-type: none"> ● Improper operation during the wiring process can cause fatal injury to operator or unrecoverable damage to the inverter. Only qualified personnel can perform the wiring work. ● All electrical installations must be in accordance with local and national electrical codes. ● All cables must be firmly attached, undamaged, properly insulated and adequately dimensioned. ● It is not allowed to close the AC and DC breakers before the inverter is electrically connected
<p>Note</p>	<ul style="list-style-type: none"> ● Read and follow the instructions provided in this section while observing all safety warnings. ● Always note the rated voltage and current defined in this manual. Never exceed the limits.

4.4.1 Connection of solar modules

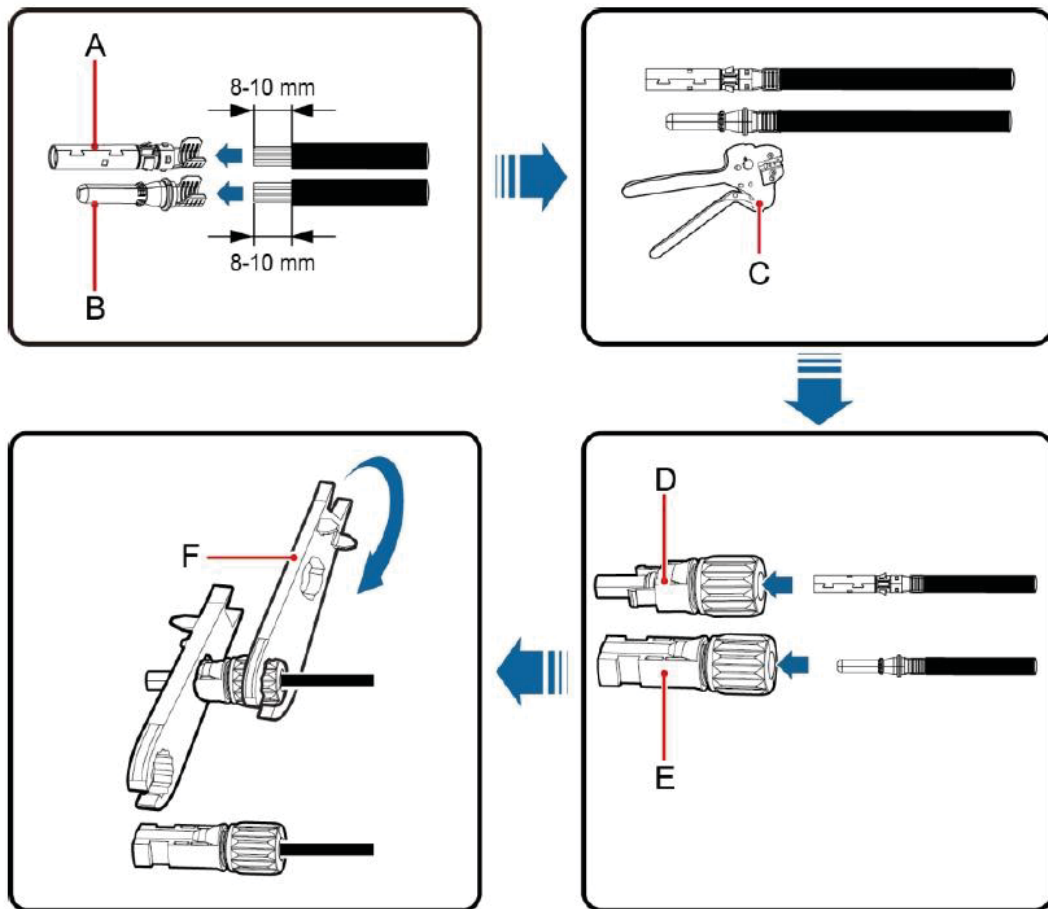

Figure 4.7 Connection between DC connector and solar modules

Connection steps:

- (1) Lighting, short-circuit and other protection measures which meet the local electrical safety laws and regulations are needed before the AC connection.



- Only qualified cables under the local electrical safety laws and regulations are allowed to connect.

- (2) Connect the output cables of solar modules to the DC connector as Figure 4.7 shows.

Loose the nut of connector and remove the isolation layer of the DC cable for about 15mm. Insert it into the connector and press until hear the lock sound. Finally lighten the nut to a torque of 2.5-3 Nm. The wiring of negative pole is the same Nm as that of the positive pole. Ensure the poles of solar modules are well connected with the connectors;

- (3) After the DC connector is connected, use a multimeter to measure the voltage of the DC input string, verify the polarity of the DC input cable, and ensure that the voltage of each string is within the allowable range of the inverter, as shown in Figure 4.8.

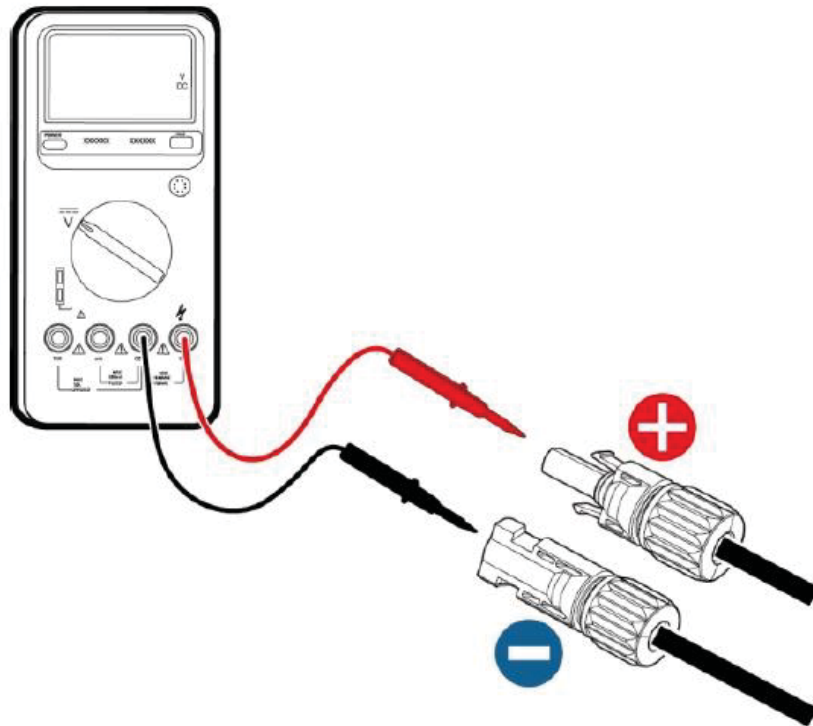

Figure 4.8 DC input voltage measuring



- The solar modules connected with the inverter needs to be the configured ones other than some connecting devices without authorized. Otherwise, device damage, unstable operation or fire may occur.

- (4) Connect the DC connector with the inverter and ensure tightly-fastened;
- (5) Insert the screw-driver into the hole of the connector to remove the connector from the inverter.
- (6) Unclench the pressed cover with screw-driver to remove the cables from the connector.

4.4.2 AC connection

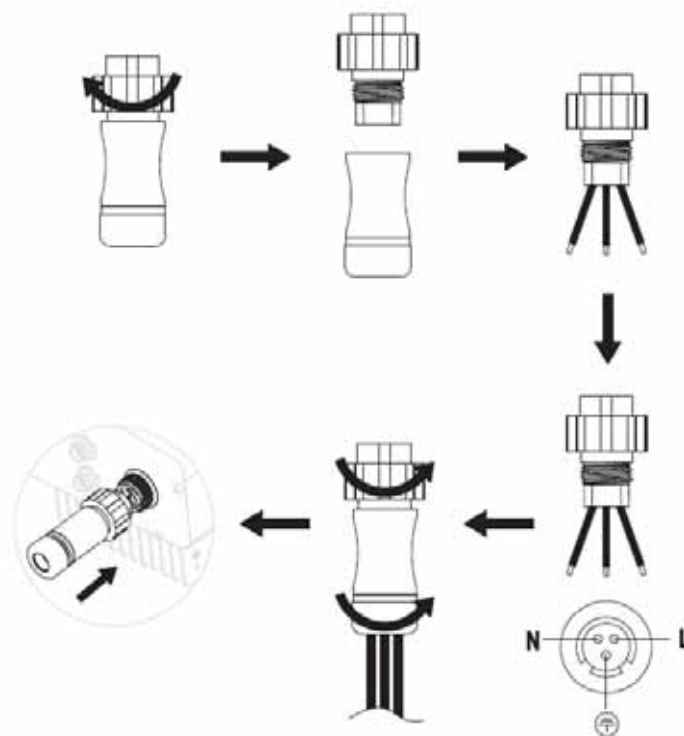

Figure 4.9 AC connection of single-phase inverter

Connection steps of single-phase inverter:

- (1) Before connecting the single-phase AC grid cable to the inverter, take lightning and short circuit protection measures in accordance with the local electrical safety codes;
- (2) As shown in Figure 4.9, connect and fasten L, N and PE conductors of the single-phase common grid to AC terminal tighten to 0.5 Nm, assemble the terminal tighten to 2.5-3 Nm, and then connect the terminal to the AC port of the inverter.
- (3) Fix and connect the DC output cables of PV board with the matched DC connectors, and then connect the connectors to the DC port of the inverter.



- Only qualified cables under the local electrical safety laws and regulations are allowed to connect.
- Only with the permission of the local electric power company can the inverter be connected to the utility grid.

5 Operation

This chapter describes detailed operation of the inverter which involves the inspection before operation, grid-tied operation, stopping and daily maintenance of the inverter.

5.1 Inspection before operation

Check as follows before operation (including but not limited to):

- (1) Ensure the installation site meet the requirement mentioned in section 4.2.2 for easy installation, removing, operation and maintenance;
- (2) Ensure the mechanical installation meet the requirement mentioned in section 4.3;
- (3) Ensure the electrical installation meet the requirement mentioned in section 4.4;
- (4) Ensure all switches are “off”;
- (5) Ensure the voltage meet the requirement mentioned in chapter 9;
- (6) Ensure all electrical safety precautions are clearly-identified on the installation site.



- Do check as above before any operation if the system or inverter needs to be installed, refitted and maintained.

5.2 Grid-tied operation

Note

- When power on the inverter for the first time, please refer to section 6.5 to complete grid certification choice.
- Keep the inverter power on at least 30 minutes to charge for the internal clock battery.

Please start the inverter as follows:

- (1) Ensure the requirements mentioned in section 5.1 are met;
- (2) Switch on the breakers at the AC side;
- (3) Switch on the integrated DC switch;
- (4) Switch on the switch on the DC side;
- (5) Observe the LED indicators and information displayed on the screen. Refer to chapter 6 for detailed information.

 Run Green indicator blinks, others off: the inverter is power on and in self-inspection;

 Run Green indicator on, others off: the inverter is in power generation after self-inspection---successful commissioning.

“Warn” or “Fault” indicators are on or blinking: the inverter is power on, but fault occurs.

Please refer to section 6.3 for detailed information, and then stop as the section 5.3 mentioned, finally settle the problems as chapter 8. If all faults are solved, do as chapter 5 mentioned.

5.3 Stopping

Stop the inverter as follows if it needs maintenance, inspection and troubleshooting:

- (1) Switch off the breakers at the AC side;
- (2) Switch off the integrated DC switch;
- (3) Switch off the switch on the DC side;
- (4) Wait at least 5 minutes until the internal parts and components are discharged. And then stop the inverter.

5.4 Daily maintenance

The inverter can perform power generation, start and stop automatically even the day and night shifts and seasons change in one year. In order to prolong the service life, daily maintenance and inspection are needed besides following the instructions mentioned in this manual seriously.

5.4.1 Regular maintenance

Maintenance contents	Maintenance methods	Maintenance cycle
Store the operation data	Use real-time monitoring software to read inverter running data, regularly back up all inverter running data and stats. Check the monitoring software and inverter LCD screen to make sure the parameters are set correctly.	Once each quarter
Check inverter operation status	Check to make sure the inverter installation is solid, no damage or deformation. When inverter running, check to make sure the sound and variables are normal. When inverter running, use thermal imager to check whether the case cooling is normal.	Every six months
Clean the surface	Check the ambient humidity and dust around inverter, clean the inverter when necessary. See Section 5.4.2.	Every six months
Check electrical connection	Check the cable connection and inverter terminals, make sure they are connected reliably, not loose, and no damage, insulation reliable.	Every six months

Maintenance contents	Maintenance methods	Maintenance cycle
Check the security features	Check the off-on feature of inverter: use monitoring software or LCD and keyboard on the inverter, do "off" and "on" operation, to confirm its off-on feature intact. At the same time, make sure monitoring software can normally communicate with the inverter. Check the warning label on or around the inverter, if necessary replaced.	Every six months

5.4.2 Maintenance guide

Clean the inverter

Cleaning procedure is as follows:

- (1) Disconnect the input and output switches.
- (2) Wait ten minutes.
- (3) Use a soft brush or a vacuum cleaner to clean the surface and the inlet and outlet of the inverter.
- (4) Repeat Section 5.1 operating content.
- (5) Restart the inverter.

6 Display panel

This chapter describes the panel displaying and how to operate on the panel, which involves the LCD display, LED indicators and operation panel.

6.1 LED indicators

There are three LED indicators on the panel:

- (1) “Run”, operation indicator, green;
- (2) “Warn” recoverable fault indicator, yellow;
- (3) “Fault”, unrecoverable fault indicator, red.

The inverter state includes 6 states of stand-by, self-inspection, power generation, recoverable fault and unrecoverable fault; LED indicators are on, off and blinking. Please refer to table 6-1 for detailed state of inverter and LED indicators state.













“○”: LED indicator is off;

“◐” (green), “◑” (yellow), “◒” (red): LED indicator is blinking at every 0.25S or 0.5S;

“●”(Green), “●”(yellow), “●”(red): LED indicator is on.

Table 6-1 Inverter state and LED indicators

Inverter state	LED indicators	Description
Stand-by	○ Run ○ Warn ○ Fault	No power on. All indicators off.
Self-inspection	◐ Run ○ Warn ○ Fault	Green indicator blinks in every 0.25s, others off. Power on and ready for self-inspection
Power generation	● Run ○ Warn ○ Fault	Green indicator keeps on, others off. Grid-tied power generation.
	● Run ● Warn ○ Fault	(1) Grid-tied power generation, but clock fault (A007); (2) Grid-tied power generation, but DC input fault (A001 or E001); (3) Grid-tied power generation, but fan fault(E006 or E012); Green and yellow indicator keeps on, others off.
Recoverable fault	○ Run ◑ Warn ○ Fault	Inverter stand-by. The public grid fault(A001, A003, A004, A005or A006); Yellow indicator blinks in every 0.5s, others off

Inverter state	LED indicators	Description
	<ul style="list-style-type: none">  Run  Warn  Fault 	(1) Inverter stand-by. Temperature abnormal(E006); (2) Inverter stand-by. DC input fault (E001); Yellow indicator keeps on, others off
Unrecoverable fault	<ul style="list-style-type: none">  Run  Warn  Fault 	Hardware or software fault (E003, E004, E005, E008, E009, E011, E013 or E015). De-couple the inverter from the system before maintenance. Red indicator blinks in every 0.5s, others off
	<ul style="list-style-type: none">  Run  Warn  Fault 	Current-leakage or unqualified output power energy of the inverter (E007, E010, E014, E017, E018 or E020). De-couple the inverter from the system before maintenance. Red indicator keeps on, others off
Artificial turned off	<ul style="list-style-type: none">  Run  Warn  Fault 	Stop after the communication or panel command. All indicators are on.
Note	Please refer to chapter 5 and 7 for detailed fault information and troubleshooting.	

6.2 Operation panel

There are 4 buttons on the panel:

- (1) “ESC”, exit and return ;
- (2) “^”, back to the front page and data increasing;
- (3) “v”, to the next page and data decreasing;
- (4) “ENT”, enter.

The machine can be turned on and off by pressing the buttons: press "ESC" and "ENT"(about 3 seconds) at the same time, and then the quick start-up and stop is available.

6.3 LCD screen

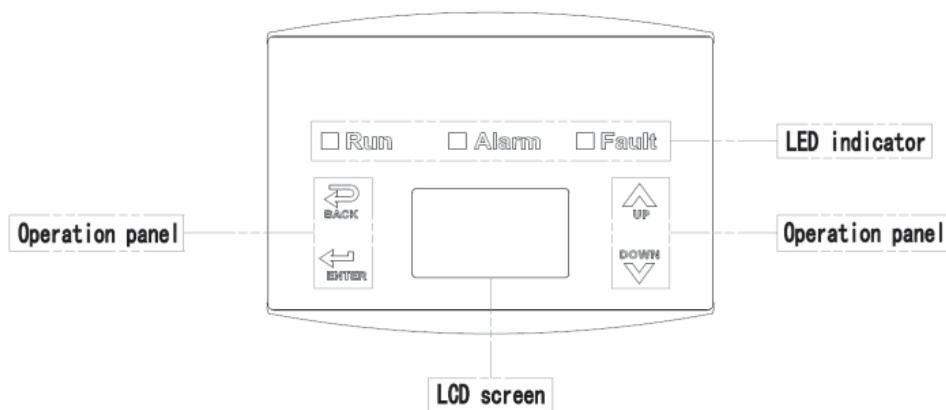

Figure 6.1 Operation panel

All information is displayed on the LCD screen. The background illumination of LCD screen will go out to save power if there is not button operation in 15 seconds. But it can be activated by pressing any button. Press “ENT” to enter into the main interface if the background illumination is on. All parameters can be viewed and set on the interface.

There are main interface and menu interfaces on the LCD screen, of which the main interface is the default one after power on, while the menu interfaces are used to watch and set parameters or other manual operation, such as viewing the monitoring parameters, history record, system information, statistics and fault information and setting the displayed language, time, communication address, password and factory defaults.

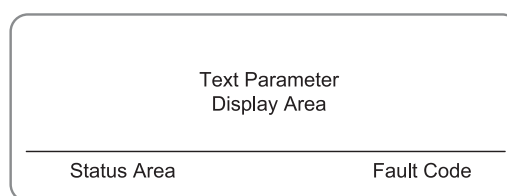

Figure 6.2 Main interface

The main interface of the LCD screen is shown as the Figure above:

- (1) The curve displays the power changing at the current day;
- (2) The words on the screen display the current key parameters of the inverter. Three lines of words are displayed at a time, but if the inverter is in operation or stand-by state, the words are rolling forward at every 3s. And the user can press “^” or “v” to look up the information freely;
- (3) 5 states of the inverter are displayed on the screen;
- (4) If the inverter is in fault or warning state, up to 8 corresponding fault codes can be displaying on the screen.

6.4 Functions operation

Most of the parameters can be viewed and set through the LCD screen and operation panel.

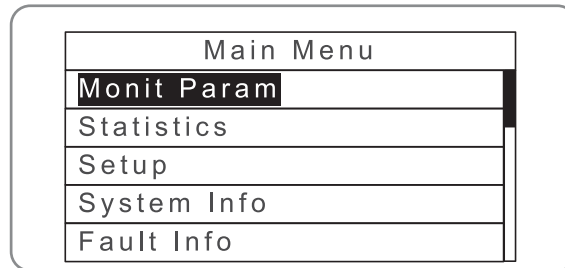

Figure 6.3 Main interface

6.4.1 Monitoring parameters

Press “^” and “v” in the main interface to select “Monit Param”, and then press “ENT” to view the parameters which is shown in Figure 6.4. Go the front or next page through “^” and “v” and return through “ESC”.

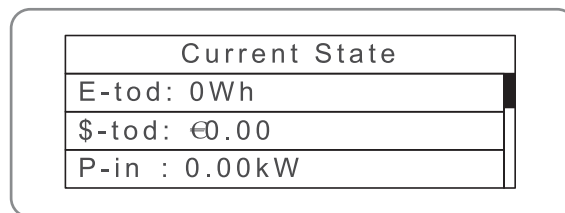

Figure 6.4 Monitoring parameters

6.4.2 History

Press “^” and “v” in the main interface to select “History”, and then press “ENT” to view the parameters which is shown in Figure 6.5.

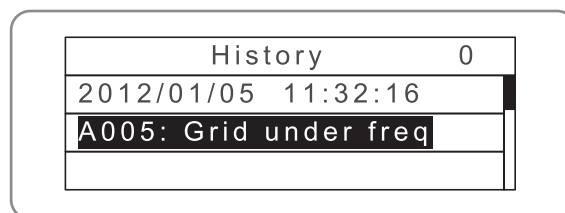

Figure 6.5 History parameters

There are 32 history records in total. Press “^” and “v” to review the history record and press “ESC” to exit. The numbers on the top right is the serial No. of the record and the numbers in the second line display date when faults occur and settled. If the color of the third line illuminates, the fault occurs, if not, the fault is solved.

6.4.3 Statistics

Press “^” and “v” in the main interface to select “Statistics”, and then press “ENT” to view the parameters which is shown in Figure 6.6.

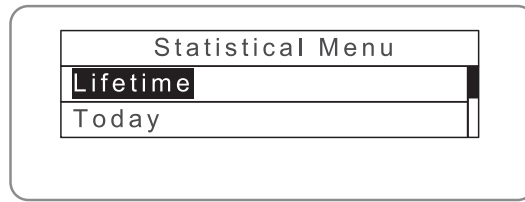

Figure 6.6 Statistic information

The information in table 6-2 can be viewed in the statistical menu.

Table 6-2 Statistic information

Content	Detailed
Lifetime	Total operation time, total power produced, total power saved, total CO ₂ reduction in lifetime
Day statistics	Total power produced, total power saved, peak power and total CO ₂ reduction in current day

6.4.4 Parameter settings

- 1) Press “^” and “v” in the main interface to select “Setup Menu”, and then press “ENT” to view the parameters which is shown in Figure 6.7. Please enter the input password 9876 first before enter “Setup Menu” and “Control Menu”.

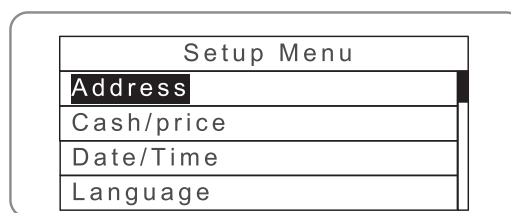
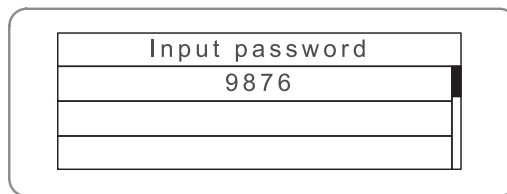
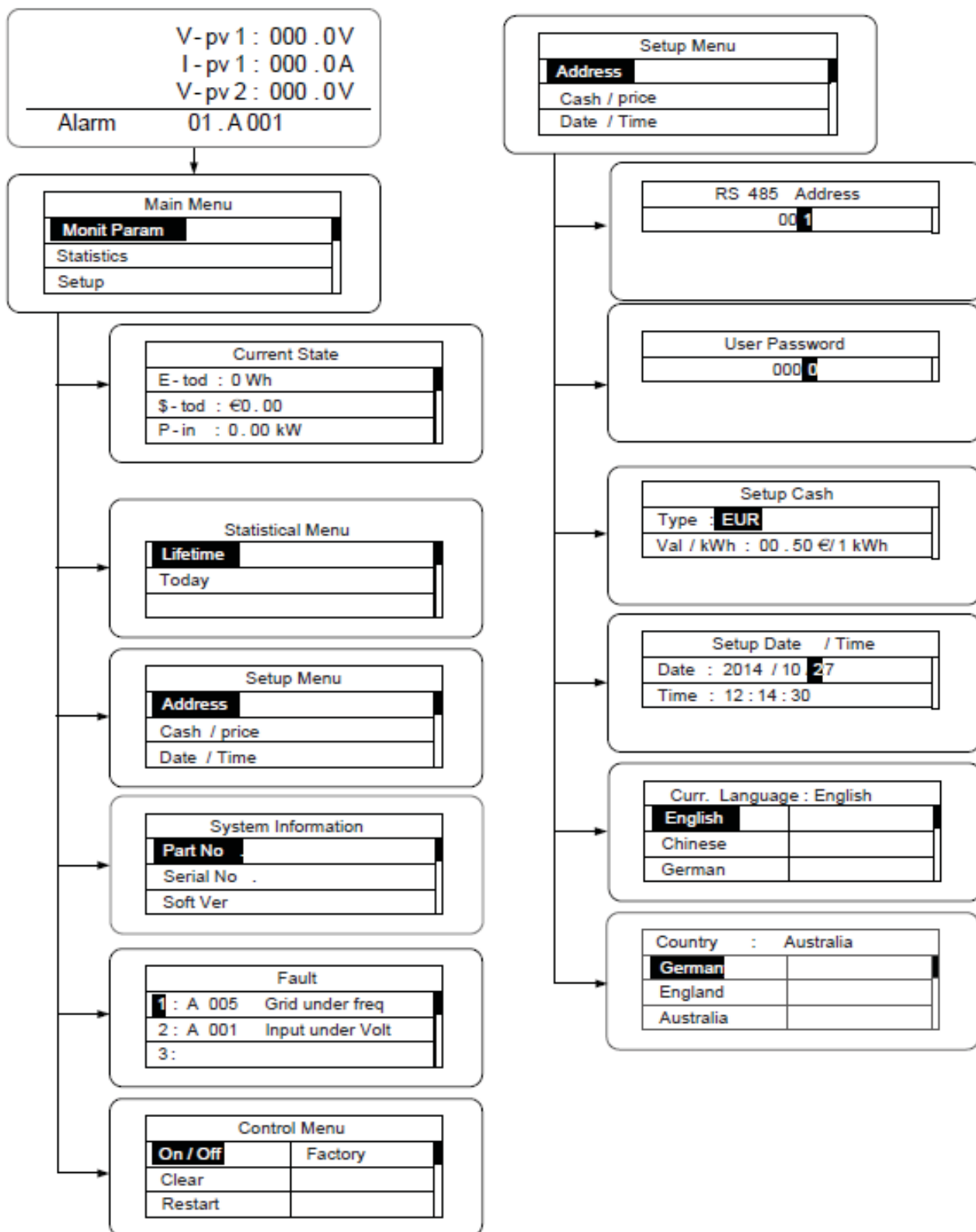

Figure 6.7 Setting information

Parameters can be set in this interface.

LCD menus:



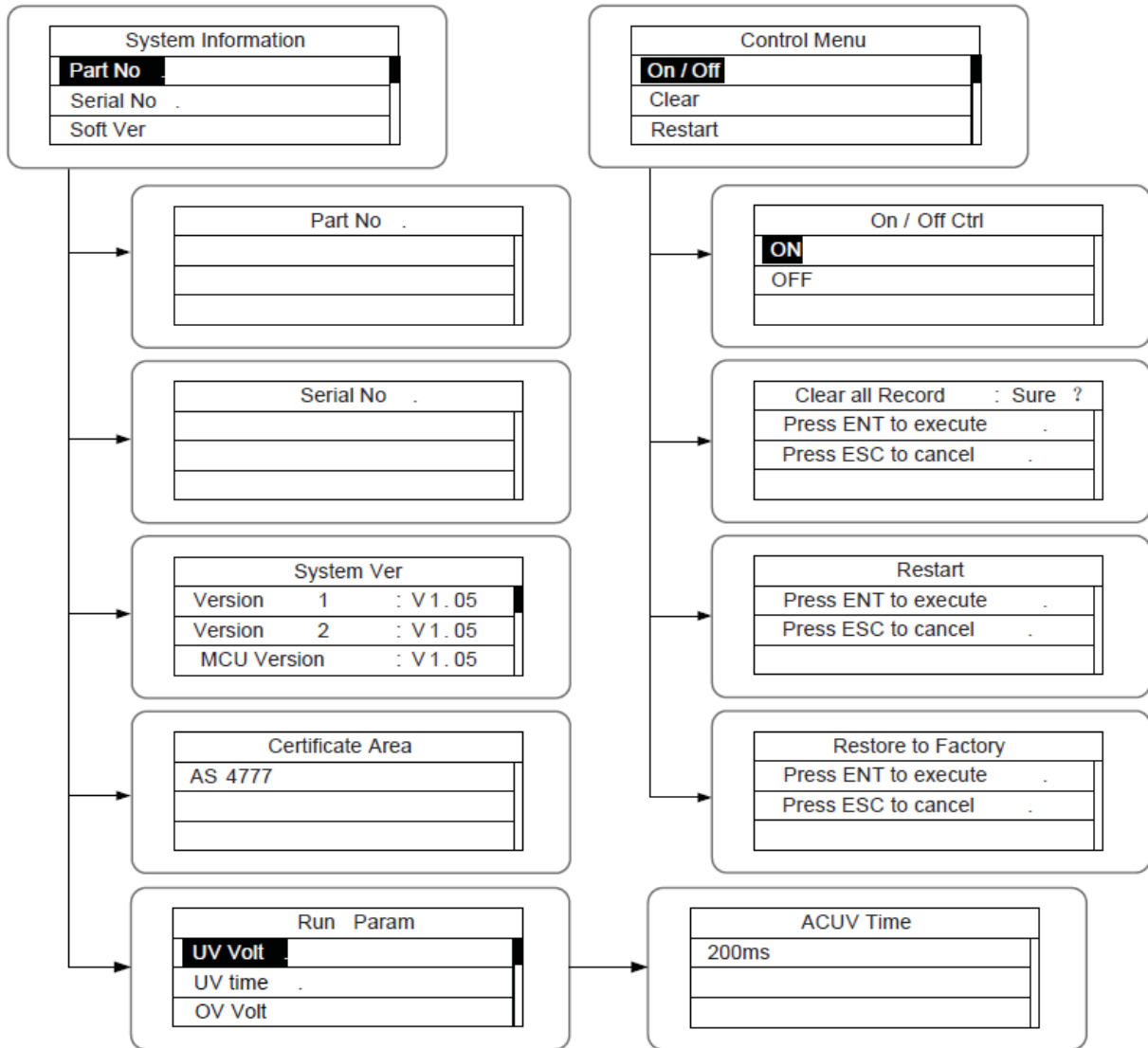

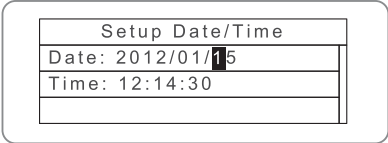
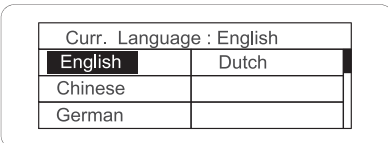
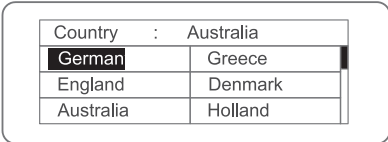



Table 6-3 Parameters setting

Setting item	LCD display	Instruction
RS485 Address		Enter into the interface and edit the data through “^” or “v”. And then press “ENT” again to the next bit. After editing the three bits, press “ENT” to save the edition and press “ESC” to exit.
User password		Enter into the interface and edit the data through “^” or “v”. And then press “ENT” again to the next bit. After editing the four bits, press “ENT” to save the edition and press “ESC” to exit.

Setting item	LCD display	Instruction
		The default password is “0000”; the user can enter into the setting interface without password. If the password is not “0000”, the user can enter into the setting interface with password.
Setup Cash		<p>Enter into the interface and edit the currency type and cash through “^” or “v”. And then press “ENT” again to the next line. After editing the four bits, press “ENT” to save the edition and press “ESC” to exit.</p> <p>The currency types include EUR, POD, CNY and USD.</p>
Setup Date/Time		<p>Enter into the interface and edit the date and time through “^” or “v”. And then press “ENT” again to the next line. After editing the four bits, press “ENT” to save the edition and press “ESC” to exit. ,</p>
Language		<p>Enter into the interface and edit the language through “^” or “v”. And then press “ENT” again to save the edition and press “ESC” to exit.</p> <p>The default language is English.</p>
Select Country		<p>Enter into the interface and select country through “^” or “v”. And then press “ENT” again to save the edition and press “ESC” to exit.</p>
Setup mode		<p>The DC input mode includes “independent” and “parallel”:</p> <p>“independent mode” is the independent MPPT of Track A and Track B; “parallel</p>

Setting item	LCD display	Instruction
		<p>mode” is the parallel MPPT of Track A and Track B.</p> <p>The default mode is “independent”.</p> <p>The input mode setting is invisible if the inverter is in power generation. It is only available during DC power on and AC power off.</p> <p>Press “^” or “v” to select the setting mode and press “ENT” to save the setting or “ESC” to return.</p> <p>If the situation of section 6.4.8 occurs, it is necessary to switch the DC input to “parallel” mode.</p>

Setting item	LCD display	Instruction						
Run Param	<p>The LCD display flowchart shows the following sequence:</p> <ul style="list-style-type: none"> Input password screen with the value 0000. Run Param menu with a grid of options: <table border="1" data-bbox="416 577 691 772"> <tr> <td>UV Volt</td> <td>OV time</td> </tr> <tr> <td>UV time</td> <td>UF Freq</td> </tr> <tr> <td>OV Volt</td> <td>UF time</td> </tr> </table> Navigation to sub-menus: <ul style="list-style-type: none"> ACUV Volt(phase volt) → 184V ACUV Time → 0.20s ACOV Volt(phase volt) → 263V ACOV Time → 0.20s ACUF Frequency → 47.6Hz ACUF Time → 0.20s ACOF Frequency → 51.4Hz ACOF Time → 0.20s 	UV Volt	OV time	UV time	UF Freq	OV Volt	UF time	<p>Password is required when enter into the interface of “Run Param”. Get the password from the supplier if necessary. Set ACUV Volt, ACUV time and others under the related submenus, and then press “^” and “v” to modify, and finally press “ENT” to confirm.</p>
UV Volt	OV time							
UV time	UF Freq							
OV Volt	UF time							

Setting item	LCD display	Instruction
<p>Run Param</p>	<p>The LCD display flowchart starts with an 'Input Password' screen showing '0000'. An arrow points down to a 'Run Param' menu with the following items: UV volt 1, OV time 1, UV time 1, UF Freq 1, OV volt 1, and UF time 1. From this menu, arrows point to a series of 18 sub-menus, each with a value:</p> <ul style="list-style-type: none"> ACUV Volt(phase volt): 115V ACUV Time: 00.04s ACOV Volt(phase volt): 309V ACOV Time: 00.02s ACUF Frequency: 47.99Hz ACUF Time: 00.12s ACOF Frequency: 50.50hz ACOF Time: 00.12s ACUV Volt(phase volt): 196V ACUV Time: 0.19s ACOV Volt(phase volt): 252V ACOV Time: 01.90s ACUF Frequency: 49.49Hz ACUF Time: 595s ACOF Frequency: 50.2Hz ACOF Time: 115s Run Restart Time: 060s Island protect:on: OFF/ON 	<p>There are 2 protections under G83/G59(UK) and PEA(Thailand) standards, and there is only one protection under other grid tied standard. Set ACUV Volt, ACUV time and others under the related submenus, and then press “^” and “v” to modify, and finally press “ENT” to confirm. Generally, it is only necessary to set ACUV and ACUF value for ACUV and ACUF protection. And it is necessary to set ACOF1 and ACOF2 together for ACOF protection.</p>

6.4.5 System Information

Press “^” and “v” in the main interface to select “System Information”, and then press “ENT” to view the parameters which is shown in Figure 6.8.

System Information	
Part No	.
Serial No	.
Soft Ver	

Figure 6.8 System information

The system information include “product model”, “serial No.”, “software version” and “certificate version”.

System Ver	
Version1	: V1.05
Version2	: V1.05
MCU Version	: V1.05

Figure 6.9 System version

6.4.6 Faults

Press “^” and “v” in the main interface to review the fault history, and then press “ENT” to view the sub-menu which is shown in Figure 6.10.

Fault	
1:	A005 Grid under freq
2:	A001 Input under Volt
3:	

Figure 6.10 Fault information

There are 8 pieces of fault information in the record which is shown in Figure 6.10; otherwise it will display “No Fault!” Refer to section 6.4.2 for more detailed information.

6.4.7 Inverter control

Press “^” and “v” in the control interface, and then press “ENT” to view the sub-menu which is shown in Figure 6.11.

Control Menu	
On/Off	Factory
Clear	
Restart	

Figure 6.11 Control interface

Refer to the table below for detailed information.

Table 6-4 Inverter control

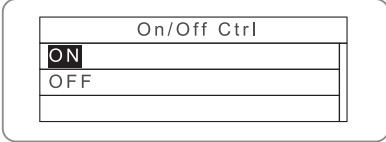
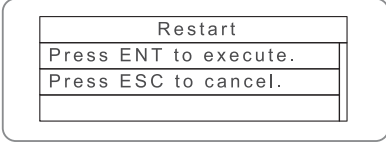
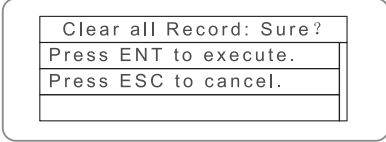
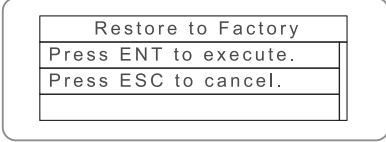
Control item	LCD display	Instruction
On/Off control		Control the “On/Off” through the panel. Press “^” and “v” in the control interface to select the operation. Press “ENT” to ensure the operation and press “ESC” to return.
Restart		Restart the inverter through the panel. And save the all settings and operation record. Press “ENT” to ensure restarting and the inverter will begin to self-inspect or press “ESC” to return.
Record clear		Press “ENT” to ensure clear all records or press “ESC” to return. “Record clear” is to clear all setting parameters through the panel, restore to the factory setting and save all history operation records.
Restore to factory		“Restore to factory” is to clear all setting parameters and history operation records through the panel, restore to the factory setting. Press “ENT” to ensure clear or press “ESC” to return.

6.4.8 Mode settings

The default mode of series grid-tied solar inverter is “independent”. But if the current of solar modules are joined into the inverter as Figure 6.12 shows, it is necessary to switch the mode into “parallel”.

Note	<ul style="list-style-type: none"> ● Only where there is more than 100V DC voltage input, LCD display working, and AC switch off, can query and modify the inverter DC input mode via the LCD screen and keypad.
-------------	---

6.5 Grid Certification Choice

Power on the inverter by DC input for the first time or after Restore factory settings, it will appear on the LCD screen prompts as follows:



Waiting a few seconds later, in the LCD screen will appear a list of countries as follows, requiring the user to choose what country of use. As shown below:

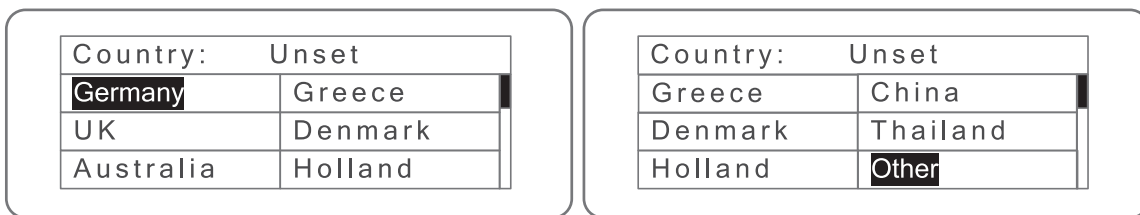

Press the “^” or “v” button to navigate the country, press the ENT button to complete the setting.

After determine the location, please follow the user manual required with the proper use of inverter.

The user can change the location through the following ways:

LCD Screen: MENU→Main Menu: Setup→Setup Menu: Country→Country:

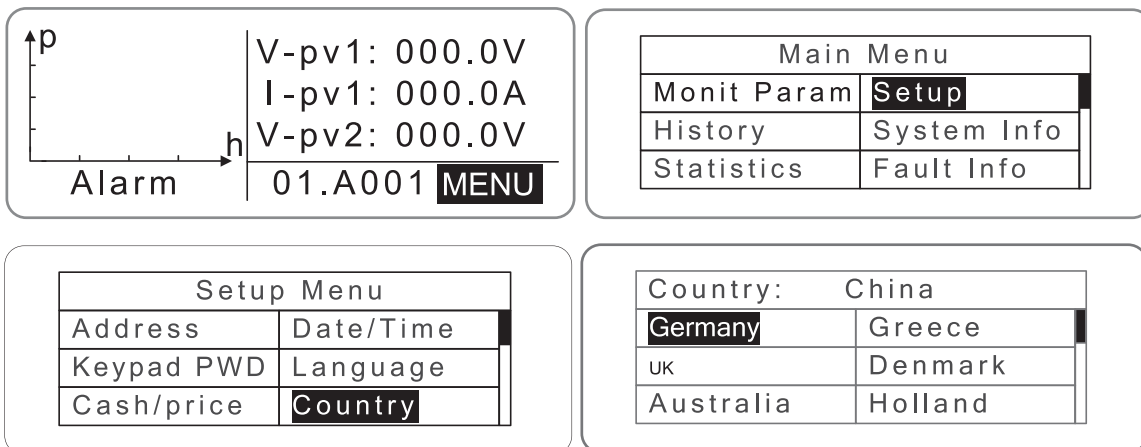

The user can query the grid certification which has been set through the following ways:

LCD Screen: MENU→Main Menu: System Info→System Information: Cert. Area→Certificate Area

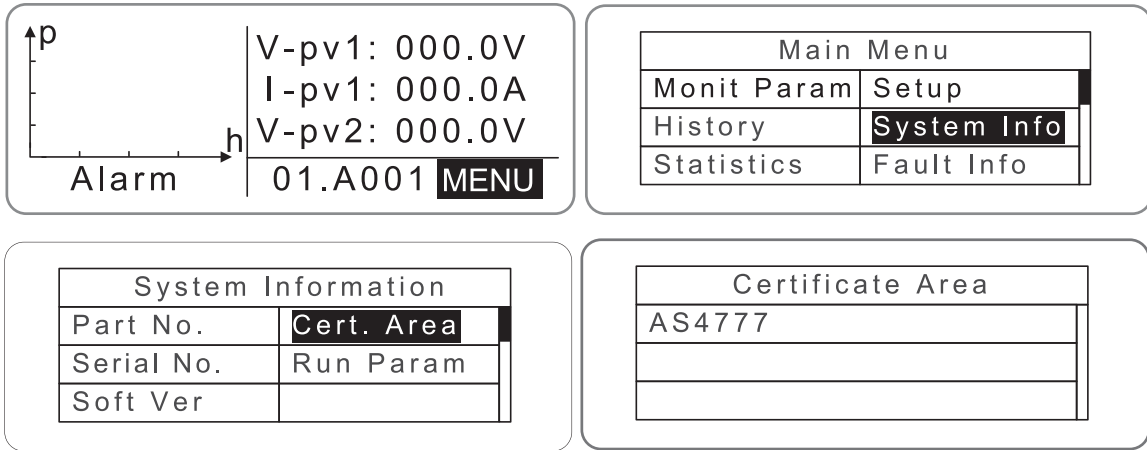

Comparison Table: Available countries and their grid certification

No.	Country	Certification	Remark
1	Germany	VDE0126& AR-N4105	
2	UK	G83/G59	
3	Australia	AS4777	
4	Greece	VDE0126	
5	Denmark	TF321	
6	Holland	C10/C11	
7	China	CQC	
8	Thailand	PEA	
9	Other	VDE0126	

Reference Table: Grid certification and grid voltage and frequency of some countries

No.	Country	Certification	Single-phase voltage	Grid frequency
1	Germany	VDE0126& AR-N4105	220~230V	50Hz
2	France			
3	Greece			
4	Turkey			
5	Romania			
6	Slovakia			
7	Portugal			
8	Poland			
9	Hungary			
10	Switzerland			
11	Austria			
12	UK	G83-2/G59-3	240V	50Hz
13	Australia	AS4777.2&AS4777.3 AS/NZS3100	230~240V	50Hz
14	Singapore			
15	New Zealand			
16	Belgium	C10/C11	220~230V	50Hz
17	Luxembourg			
18	Holland			
19	Denmark	TF3.2.1	220~230V	50Hz
20	Thailand	PEA	220V	50Hz
21	China	CGC/CF001	220V	50Hz
22	Italy	ENEL	230V	50Hz

7 Monitoring communication

This chapter describes the communication connection of inverter and monitoring system (Industrial master, private computers, smart phones and so on).

7.1 RS485-M and CT/METER ports

The standard communication mode of iMars grid-tied solar inverter is RS485 which includes “RS485-M” and “CT/METER” ports. The RS485-M port can communicate with private computers, smart phones and so on. The system monitoring solution is shown as Figure 7.1. The CT/METER port can connect the CT to detect the inverter output current or communicate with INVT Smart Meter to realize anti-reflux function.

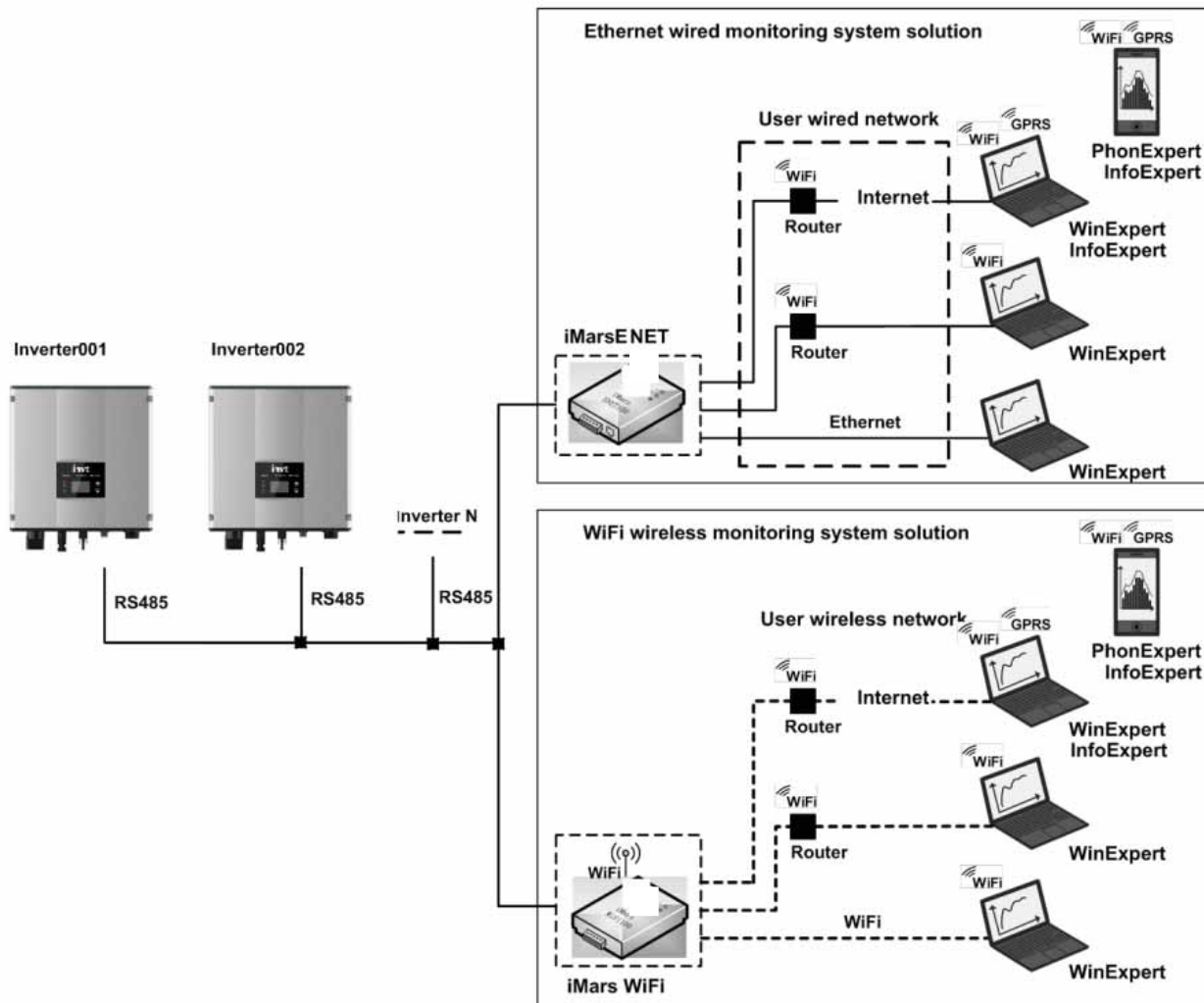

Figure 7.1 Monitoring system of inverter

7.1.1 Standard communication

Table 7-1 Pins on inverter instruction

Pin on inverter	Definition
1	+5VDC
2	A (RS485+)
3	B (RS485-)
4	GND



Figure 7.2 RS485 pin on inverter



Figure 7.3 Communication connector

Connection steps:

- (1) Weld communication cables to the RS485 terminals of the inverter as Figure 7.4 shows. Ensure the cable corresponds to the pin as table 7-1 shows and the welding is tight enough.

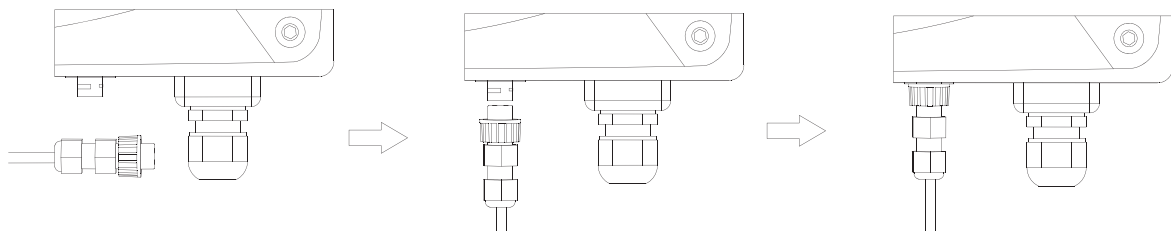

Figure 7.4 Detailed connection

- (2) According to Table 7-1, connect the communication connector pinout and the user's device, make sure the connection is correct.
- (3) Please download the monitoring software "iMars WinExpert" and its operation instruction.

7.2 RS485-DRM ports

Table 7-2 RS485-DRM Pins on inverter instruction

Pin on inverter	Colour	Definition
1	Red	RefGen
2	Yellow	Com/DRM0
3	White	DRM1/5
4	Black	DRM2/6
5	Green	DRM3/7
6	Blue	DRM4/8



Figure 7.5 RS485-DRM pin on inverter



Figure 7.6 Connection cable

RS485-DRM connection steps:

- (1) Weld communication cables to the RS485 terminals of the inverter as figure 7.6 shows; Ensure the cable corresponds to the pin as table 7-2 shows and the welding is tight enough.
- (2) According to Table 7-2, connect the communication connector pinout and the user's device, make sure the connection is correct.

8 Troubleshooting

This chapter describes the fault alarm and fault code for quick troubleshooting.

Table 8-1 Fault code

Fault code	Message	Instruction	Fault analysis
A			
A001	Input UV	Input undervoltage	PV1 undervoltage PV2 undervoltage
A002	Bus UV	Bus undervoltage	DC input
A003	Grid UV	AC undervoltage	Low voltage of the public grid
A004	Grid OV	AC overvoltage	High voltage of the public grid
A005	Grid UF	AC underfrequency	Low frequency of the public grid
A006	Grid OF	AC overfrequency	High frequency of the public grid
A007	Clock Fail	Clock alarm	Wrong setting
A009	Cmd Shut	Manual shutdown	Stop by the operation panel or upper PC
A011	Grid Loss	The public grid disconnects.	Check if inverter AC connection is well
E			
E001	Input OV	Input overvoltage	DC input overvoltage
E003	Bus OV	Bus overvoltage	Internal bus voltage
E004	Boost Fail	Voltage-boost fault	Voltage-boost fault of the inverter
E005	Grid OC	AC overcurrent	Internal AC overcurrent
E006	OTP	Overtemperature	Internal overtemperature
E007	Riso Low	Low isolation impedance	Low isolation impedance of the external port system
E008	IGBT drv	IGBT drive protection	IGBT drive protection of the inverter
E009	Int Comm	Internal communication fault	Master-slave DSP communication disabled Error of master-slave DSP check bit
E010	lLeak Fail	Huge leakage current	Huge leakage current of the system or inverter
E011	Relay Fault	Relay fault	Internal relay fault
E012	Fan Fail	Fan fault	Internal fan fault
E013	Eeprom	Memory error	Internal memory error
E014	Dc inject	High DC injection	High DC injection during AC output
E015	OutputShort	Output short-circuit	Output short-circuit
E018	Input OC	Input overcurrent	DC input overcurrent
E019	Incnst	Data consistency fault	Inconsistent grid voltage, frequency, leakage current or AC/DC injection
E020	PowerReversed	DC power reversed	DC power reversed

If any problem, please contact with the supplier and provide following information:

- Model of the inverter: _____;
- Serial No. of the inverter: _____;
- System version:——version 1: _____;
 ——version 2: _____;
 ——MCU software version: _____;
- Fault code: _____;
- Fault description _____

9 Technical parameters

Table 9-1 Technical parameters

Model		Single-phase								
		MG750TL	MG1KTL	MG1K5TL	MG2KTL	MG3KTL	MG4KTL	MG4K6TL	MG5KTL	
Input (DC)	Max. DC voltage (V)	400	450	450	450	500	600	600	600	
	Starting voltage (V)	60	80	80	120	120	120	120	120	
	MPPT voltage(V)	50-400	60-400	80-410	100-410	120-450	125-550	125-550	125-550	
	Operation voltage (V)	100-320	121-360	165-360	180-360	210-400	240-500	240-500	250-500	
	MPPT/strings per MPPT	1/1	1/1	1/1	1/1	1/2	1/2	1/2	1/2	
	Max. DC power (W)	900	1200	1700	2200	3300	4000	4600	5000	
	Max. input current (A)	8x1	9x1	10x1	12×1	15×1	16×1	18×1	20×1	
	Isc PV	8.8	9.9	11	13.2	16.5	18	20	22	
	Max inverter backfeed current to the array(A)	0	0	0	0	0	0	0	0	
	DC switch	Optional								
Output (AC)	Max output power	750	1000	1500	2000	3000	3680	4200	4600	
	Voltage(V)/ frequency(Hz)	180~270Vac、50Hz(47~51.5Hz) / 60Hz(57~61.5Hz) VDE0126& AR-N4105、AS4777.2/AS4777.3、CQC、G83-2、G59-3、C10/11、TF3.2.1、PEA								
	Max. AC current (A)	3.6	4.5	6.5	9	13	16	18.3	20	
	Maximum output overcurrent protection	6.1	7.6	11.0	15.3	22.0	33.5	37.9	40.2	
	Maximum output fault current	40A, 19.5ms					104A, 37.2ms			
	AC inrush current	Less than 10 A					Less than 2 A			
	Power factor	-0.95~+0.95 (adjustable)								
	Harmonic distortion	< 3% (rated power)								
System	Cooling	Natural cooling								
	Maximum efficiency	96.90%	97.20%	97.30%	97.40%	97.60%	97.60%	97.40%	97.50%	
	European efficiency	96.00%	96.10%	96.30%	96.50%	96.50%	96.50%	96.50%	96.50%	
	MPPT efficiency	99.9%								
	Protection degree	IP65								
	Power consumption	< 1W								
	Isolation mode	Transformerless								
	Protective class	VI								
	Overvoltage category	AC:III,PV:II								
	inverter topology	Non-isolated								
	Pollution degree	3								
	Operation temperature	(-25℃~+60℃) , derate after 45℃								
	Relative humidity	4~100%, Condensation								
	Max. altitude(m)	<2000 (derate if the altitude>2000)								
	Displaying	LED/ LCD, backlit display								
	System language	English, Chinese, German, Dutch								
	Communication	RS485 (standard); handheld keypad; WiFi (optional)								
	DC terminal	BC03A/ BC03B								
Noise dB(A)	≤25									
Installation mode	Wall installation									
Protection	Input overvoltage protection, input overcurrent protection, DC isolation monitoring, DC monitoring, grounding fault current monitoring, grid monitoring, island protection, short circuit protection, overheating protection									

Model		Single-phase				
		MG3KTL-2M	MG4KTL-2M	MG4K6TL-2M	MG5KTL-2M/	MG5K5TL-2M
Input(DC)	Max. DC voltage (V)	600	600	600	600	600
	Starting voltage (V)	120	120	120	120	120
	MPPT voltage(V)	125-550	125-550	125-550	125-550	125-550
	Operation voltage (V)	180-500	220-500	220-500	250-500	250-500
	MPPT/strings per MPPT	2/1	2/1	2/1	2/1	2/1
	Max. DC power (W)	3000	4000	4600	5000	5500
	Max. input current (A)	8×2	10×2	11×2	12×2	12×2
	Isc PV	9×2	11×2	12×2	14×2	14×2
	Max inverter backfeed current to the array	0	0	0	0	0
	DC switch	Optional				
Output(AC)	Max output power	3000	3680	4200	4600	4999
	Voltage(V)/ frequency(Hz)	180~270Vac、50Hz(47~51.5Hz) / 60Hz(57~61.5Hz)				
		VDE0126& AR-N4105、AS4777.2/AS4777.3、CQC、G83-2、G59-3、C10/11、TF3.2.1、PEA				
	Max. AC current (A)	14	16	18.3	20	22.7
	Maximum output overcurrent protection	27.0	33.5	37.9	40.2	46.0
	Maximum output fault current	104A,37.2ms				
	AC inrush current	Less than 2 A				
	Power factor	-0.95~+0.95 (adjustable)				
Harmonic distortion	< 3% (rated power)					
System	Cooling	Natural cooling				
	Maximum efficiency	97.60%	97.30%	97.40%	97.40%	97.40%
	European efficiency	96.50%	96.40%	96.50%	96.50%	96.50%
	MPPT efficiency	99.9%				
	Protection degree	IP65				
	Power consumption	< 1W				
	Isolation mode	Transformerless				
	Protective class	I				
	Overvoltage category	AC:III,PV:II				
	inverter topology	Non-isolated				
	Pollution degree	3				
	Active anti-islanding method	Method A				
	Operation temperature	(-25℃~+60℃) , derate after 45℃				
	Relative humidity	4~100%, Condensation				
	Max. altitude(m)	<2000 (derate if the altitude >2000)				
	Displaying	LED/ LCD, backlit display				
	System language	English, Chinese, German, Dutch				
	Communication	RS485 (standard); handheld keypad; WiFi (optional)				
DC terminal	BC03A/ BC03B					
Noise dB(A)	≤25					
Installation mode	Wall installation					
Protection	Input overvoltage protection, input overcurrent protection, DC isolation monitoring, DC monitoring, grounding fault current monitoring, grid monitoring, island protection, short circuit protection, overheating protection					

